

Entrematic LCU40H IP2246EN

Control panel installation manual for automations with one or two 24V motors

(Translation of the original instructions)

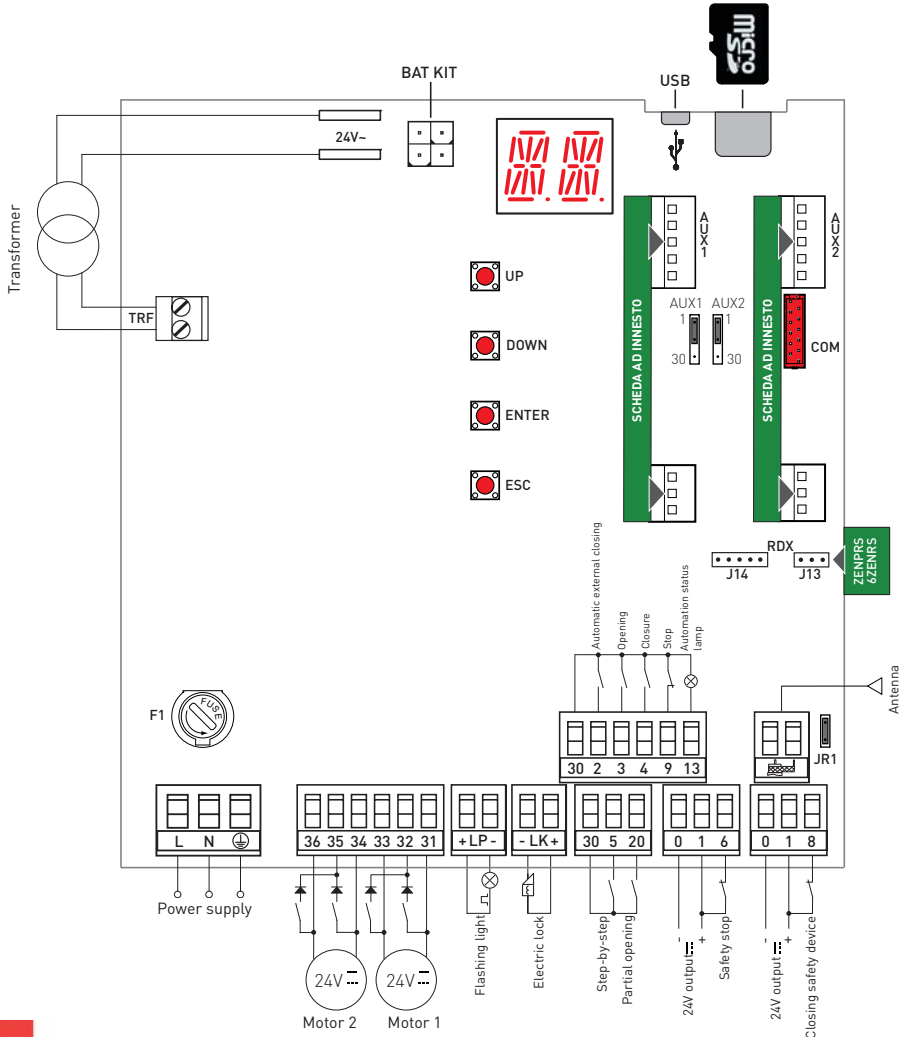

Contents

Subject		Page
1.	General safety precautions	3
1.1	Safety functions	4
2.	EC Declaration of Conformity	4
3.	Technical specifications	4
3.1	Applications	4
4.	Installation and electrical connections	5
4.1	Maintenance	7
4.2	Standard installation	7
4.3	Standard installation diagram	8
5.	Programming	9
5.1	Switching the display ON and OFF	9
5.2	Navigation keys	9
5.3	Menu map	10
6.	Quick start-up sequences	12
7.	Application examples	14
8.	Commands	16
8.1	Inserting the plug-in boards	17
8.2	SOFA1-SOFA2 or GOPAVRS self-controlled safety edge	17
9.	Outputs and accessories	18
10.	Selections	19
11.	Adjustments	20
11.1	Main menu	20
11.2	Second level menu - AT (Automatic Configurations)	21
11.2.1	Selecting the type of automation AT → AS and specific default settings	22
11.3	Second level menu - BC (Basic Configurations)	23
11.3.1	Additional BC level parameters that can be configured (available with AT → AA enabled)	23
11.4	Second level menu - BA (Basic Adjustment)	24
11.4.1	Additional BA level parameters that can be configured (available with AT → AA enabled)	26
11.5	Second level menu - RO (Radio Operations)	28
11.5.1	Additional RO level parameters that can be configured (available with AT → AA enabled)	29
11.6	Second level menu - SF (Special Functions)	30
11.6.1	Additional SF level parameters that can be configured (available with AT → AA enabled)	31
11.7	Second level menu - CC (Cycle Counter)	32
11.7.1	Additional CC level parameters that can be configured (available with AT → AA enabled)	33
11.8	Second level menu - EM (Energy Management)	33
11.8.1	Additional EM level parameters that can be configured (available with AT → AA enabled)	34
11.9	Second level menu - AP (Advanced Parameters)	34
11.9.1	Additional AP level parameters that can be configured (available with AT → AA enabled)	36
12.	Diagnostics	38
13.	Signals visualised on the display	40
14.	Troubleshooting	45

Key



This symbol indicates instructions or notes regarding safety, to which special attention must be paid.



This symbol indicates useful information for the correct functioning of the product.



Factory settings

1. General safety precautions



Failure to observe the information given in this manual may lead to personal injury or damage to the equipment.
Keep these instructions for future reference

This installation manual is intended for qualified personnel only. Installation, electrical connections and adjustments must be performed in accordance with Good Working Methods and in compliance with the present standards. This product must only be used for the specific purpose for which it was designed. Any other use is to be considered improper and therefore dangerous. The manufacturer cannot be held responsible for any damage caused by improper, incorrect or unreasonable use. Read the instructions carefully before installing the product. Incorrect installation could be dangerous.

 The packaging materials (plastic, polystyrene, etc.) should not be discarded in the environment or left within reach of children, as they are a potential source of danger.

Before installing the product, make sure it is in perfect condition.

Do not install the product in explosive areas and atmospheres: the presence of inflammable gas or fumes represents a serious safety hazard.

 The safety devices (photocells, safety edges, emergency stops, etc.) must be installed taking into account the applicable laws and directives, Good Working Methods, installation premises, system operating logic and the forces developed by the automation.

Before connecting the power supply, make sure the plate data correspond to those of the mains power supply. An omnipolar disconnection switch with a contact opening distance of at least 3 mm must be fitted on the mains supply.

Check that there is an adequate residual current circuit breaker and a suitable overcurrent cut-out upstream of the electrical installation in accordance with Good Working Methods and with the laws in force.

When requested, connect the automation to an effective earthing system that complies with current safety standards.

 During installation, maintenance and repair operations, cut off the power supply before opening the cover to access the electrical parts.

The electronic parts must be handled using earthed antistatic conductive arms. The manufacturer of the motorisation device declines all responsibility if component parts not compatible with safe and correct operation are fitted.

Only use original spare parts when repairing or replacing products.

1.1 Safety functions

The Entrematic LCU40H control panel has the following safety functions:

- obstacle recognition with force limiting;

The maximum response time of the safety functions is 0.5 s. The reaction time to a faulty safety function is 0.5 s.

The safety functions comply with the standards and performance level indicated below:

EN ISO 13849-1:2015 Category 2 PL=c

EN ISO 13849-2:2012

The safety function cannot be bypassed either temporarily or automatically. Fault exclusion has not been applied.

2. EC Declaration of Conformity

Entrematic Group AB declares that the Entrematic LCU40H control panel complies with the fundamental requisites and other relevant requirements laid down by the following EC directives:

EMC Directive 2014/30/EU;

Low Voltage Directive 2014/35/EU;

RED Directive 2014/53/EU.

Landskrona, 01-07-2016

Matteo Fino
(President & CEO)



3. Technical specifications

	LCU40H	LCU40HJ
Power supply	230 V~ 50/60 Hz	120 V~ 50/60 Hz
Power absorption	0,6 A	1,2 A
Fuse	F2 A	4 A
Motor output	24 V $\overline{\text{=}}$ 12 A max (X 2)	
Permanent power supply to accessories 0-30	24 V $\overline{\text{=}}$ 0,15 A	
Power supply to accessories 0-1 (in any case, the total of accessories 0-30 and 0-1 must not exceed 0,5A).	24 V $\overline{\text{=}}$ 0,5 A continuous	
Ambient temperature	-20 °C - +55 °C	
Storable radio codes	100 / 200 see RO → MU → 20/10 (paragraph 11.6)	
Radio frequency	433,92 MHz	
Degree of protection of the container	IP55	
Product size	238 x 357 x 120	
Operating cycles	Refer to the characteristics of the actuator used.	



NB: the given operating and performance features can only be guaranteed with the use of DITEC Entrematic accessories and safety devices.

3.1 Applications

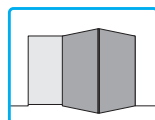
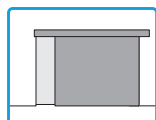
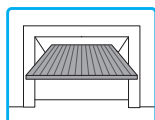
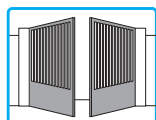
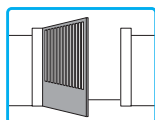

4. Installation and electrical connections

- Perforate the relevant points in the bottom part of the box (Fig. 4.1).
 - Fix the control panel firmly in place. You are advised to use convex head screws (max head \varnothing 10mm) with a cross imprint (the centre distance for the holes is shown in Fig. 4.2).
 - Insert the cable glands and corrugated tubes from the lower side of the container.
 - Before connecting the power supply, make sure the plate data correspond to those of the mains power supply.
 - An omnipolar disconnection switch with a contact opening distance of at least 3mm must be fitted on the mains supply.
 - Check there is an adequate residual current circuit breaker and overcurrent cut-out upstream of the electrical system.
 - For the power supply, use a H05RN-F 3G1.5 type electric cable. Connect it to the terminals L (brown), N (blue), \oplus (yellow/green) inside the automation (Fig. 4.3, page 6).
- NB:** the maximum permitted wire section is AWG14 (2mm²).
- Unsheathe the part of the power supply cable in line with the terminal, and use a cable fastener to hold it in place [A].
 - In order to comply with the essential requisites of the Standards in force, reclose the cover once the wires have been connected to the terminal.



The connections to the mains power supply and to any possible low voltage wires (230V) in the section outside the control panel must be made on an independent channel separated from the connections to the command and safety devices (SELV = Safety Extra Low Voltage). The corrugated tubes must enter the control panel by a few centimetres via the holes on the base box.

- Make sure there are no sharp edges that may damage the cables.
- Make sure the mains power wires (230V) and the accessory wires (24V) are separated.
- The cables must have dual insulation, be sheathed near the relative connection terminals, and be held in place with ties [B] (not supplied).
- If necessary, fit the clip hinges on the bottom of the box and on the cover (left or right side, as preferred) (Fig. 4.4, page 6).

After making the adjustments and settings, fix the cover in place with the screws supplied (Fig. 4.5, page 6).

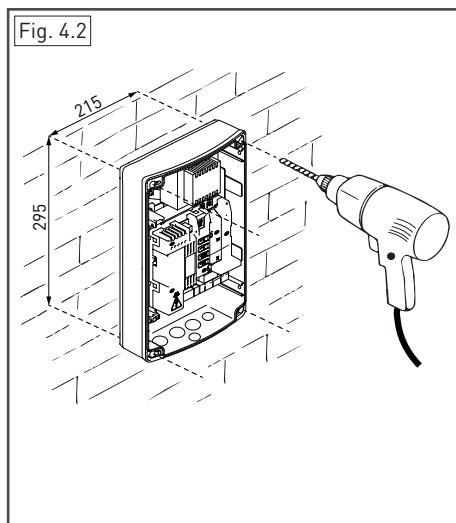
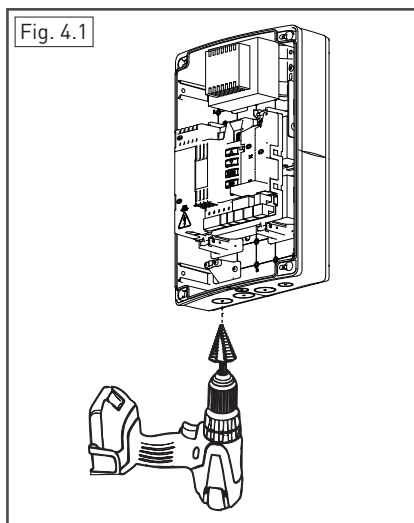

Fig. 4.3

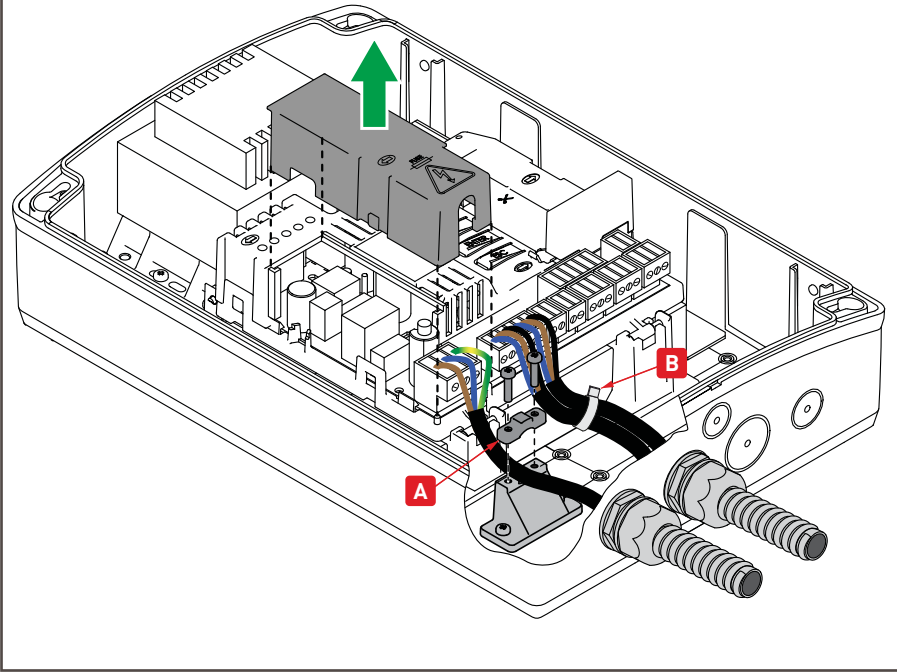

Fig. 4.4

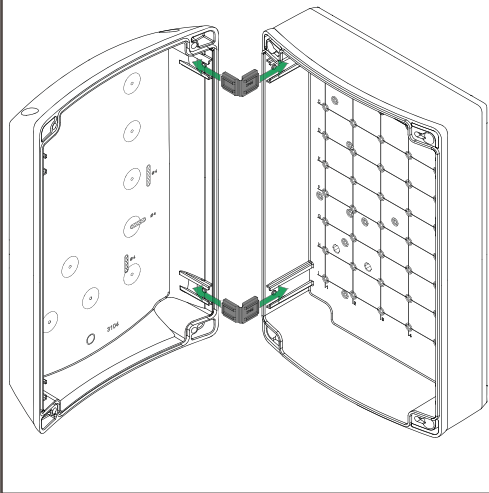
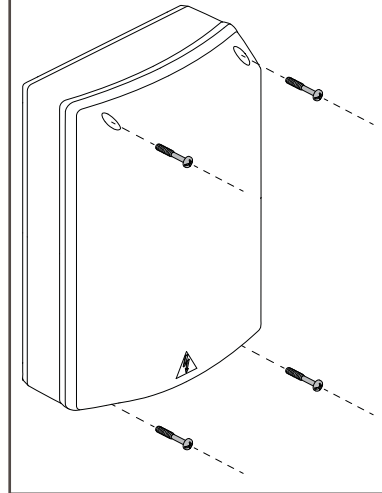

Fig. 4.5



4.1 Maintenance

The control panel needs no special maintenance.

Make regular checks to ensure the good condition of the box seals and the electrical connections.

4.2 Standard installation

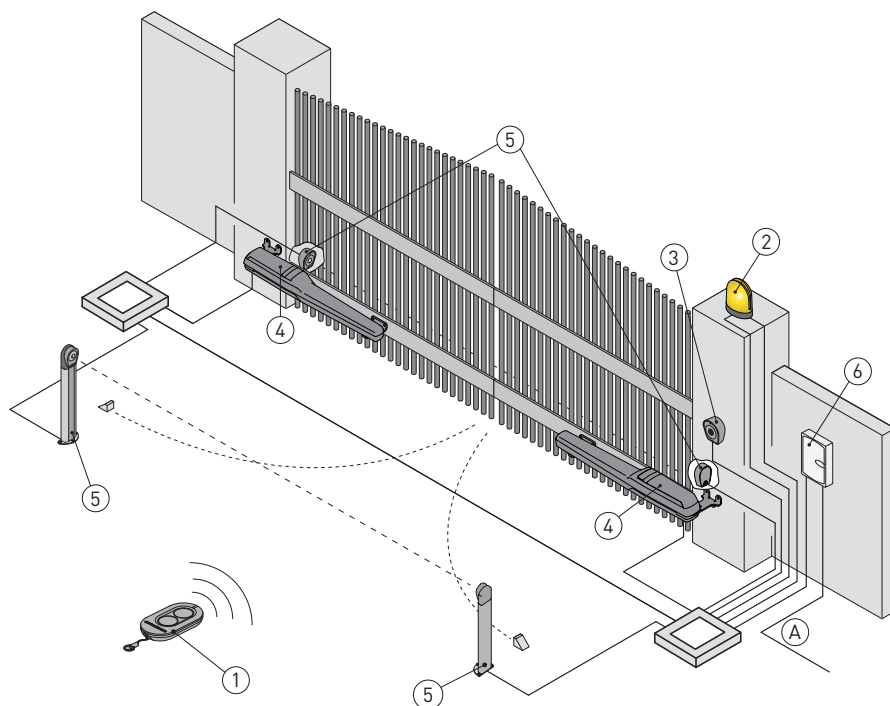

Ref.	Description	Cable
1	Transmitter	/
2	Flashing light	2 x 1mm ²
	Antenna (integrated in the flashing light)	coaxial 50 Ω
3	Key selector switch	4 x 0.5mm ²
	Digital combination wireless keypad	/
4	Actuator	2 x 1.5mm ²
	Actuator with limit switch	3 x 1.5mm ²
5	Photocells	4 x 0.5mm ²
6	Control panel	3G x 1.5mm ²
A	Connect the power supply to a type-approved omnipolar switch, with a contact opening distance of at least 3mm (not supplied). Connection to the mains must be via an independent channel, separated from the connections to the command and safety devices.	

4.3 Standard installation diagram

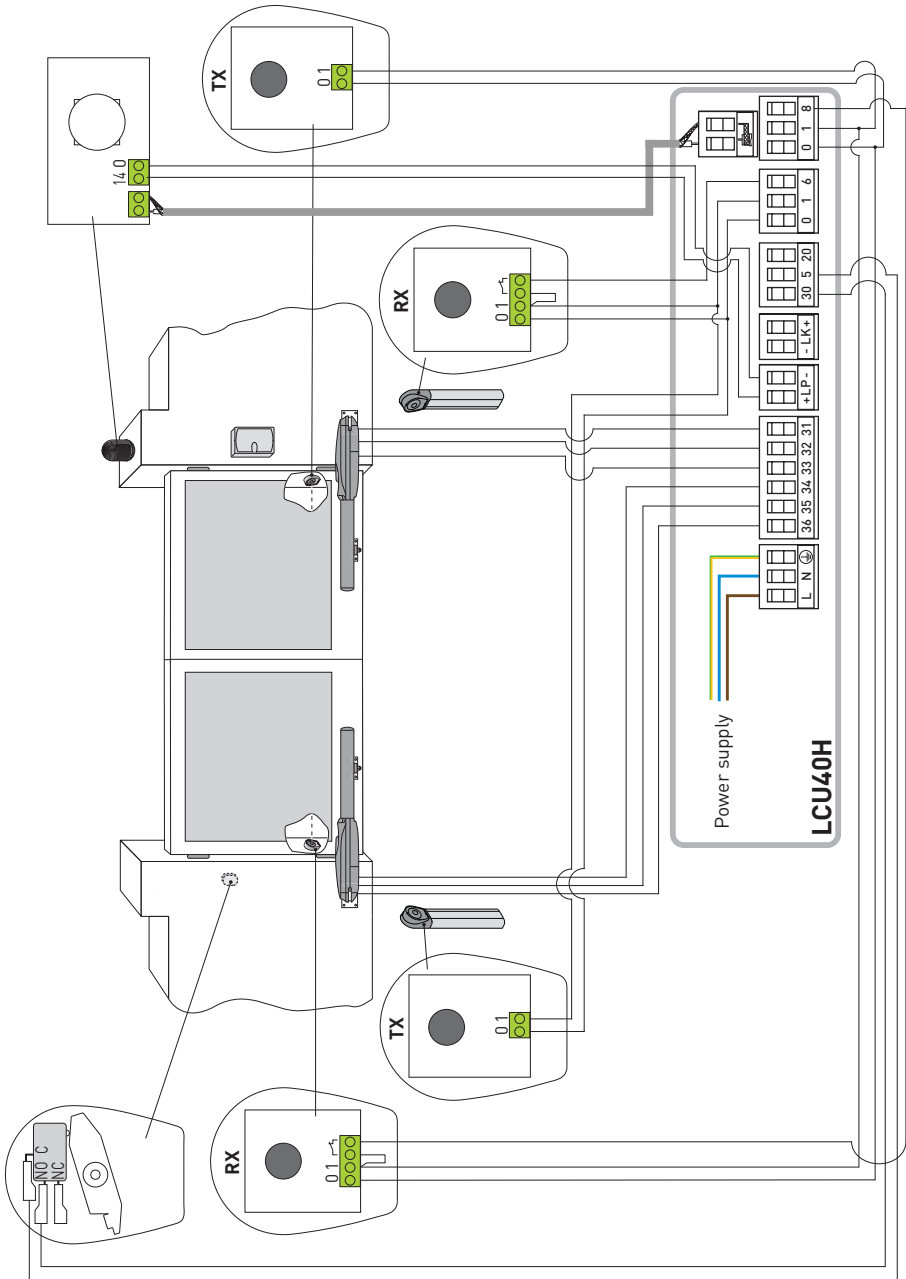

5. Programming



NB: pressure on the keys may be quick (less than 2 s) or prolonged (longer than 2 s). Unless specified otherwise, quick pressure is intended.
To confirm the setting of a parameter, prolonged pressing is necessary.

5.1 Switching the display ON and OFF

The procedure to switch on the display is as follows:



- press the ENTER key
- the display functioning check starts
- the first level menu is displayed

The procedure to switch off the display is as follows:

- press the ESC key

NB: the display switches off automatically after 60 s of inactivity.

5.2 Navigation keys

- The simultaneous pressing of the ↑ and ENTER keys produces an opening command.

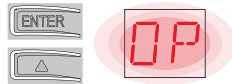

- The simultaneous pressing of the ↓ and ENTER keys produces a closing command.



- The simultaneous pressing of the ↑ and ↓ keys produces a POWER RESET command (power supply interruption and automation restart).



- Keep the UP ↑ or DOWN ↓ key pressed to begin fast menu scrolling.
- In some menus, the parameter measurement unit can be viewed by pressing the ENTER key once the value has been displayed.

Example: setting of 10 seconds for parameter OB.



5.3 Menu map

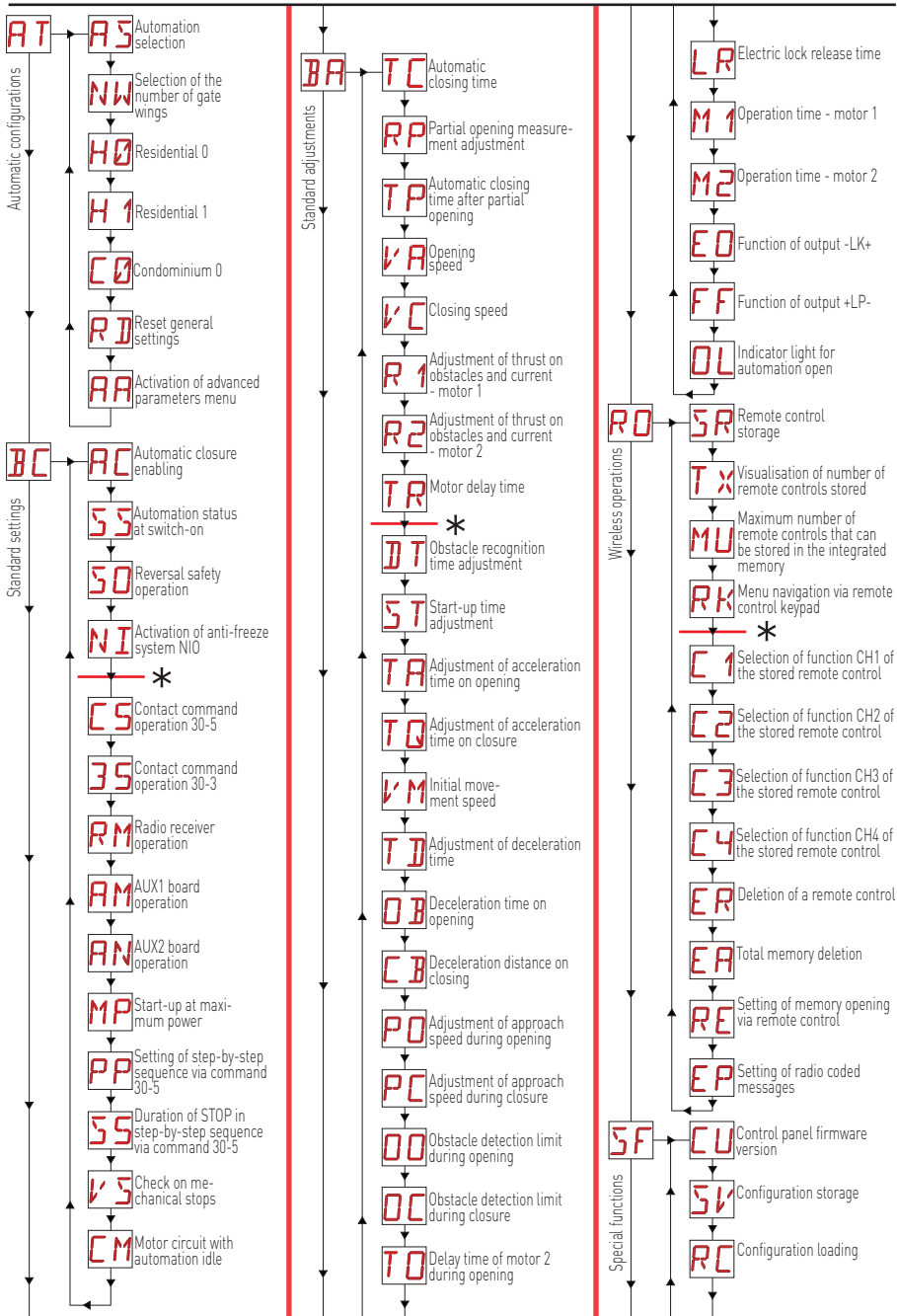

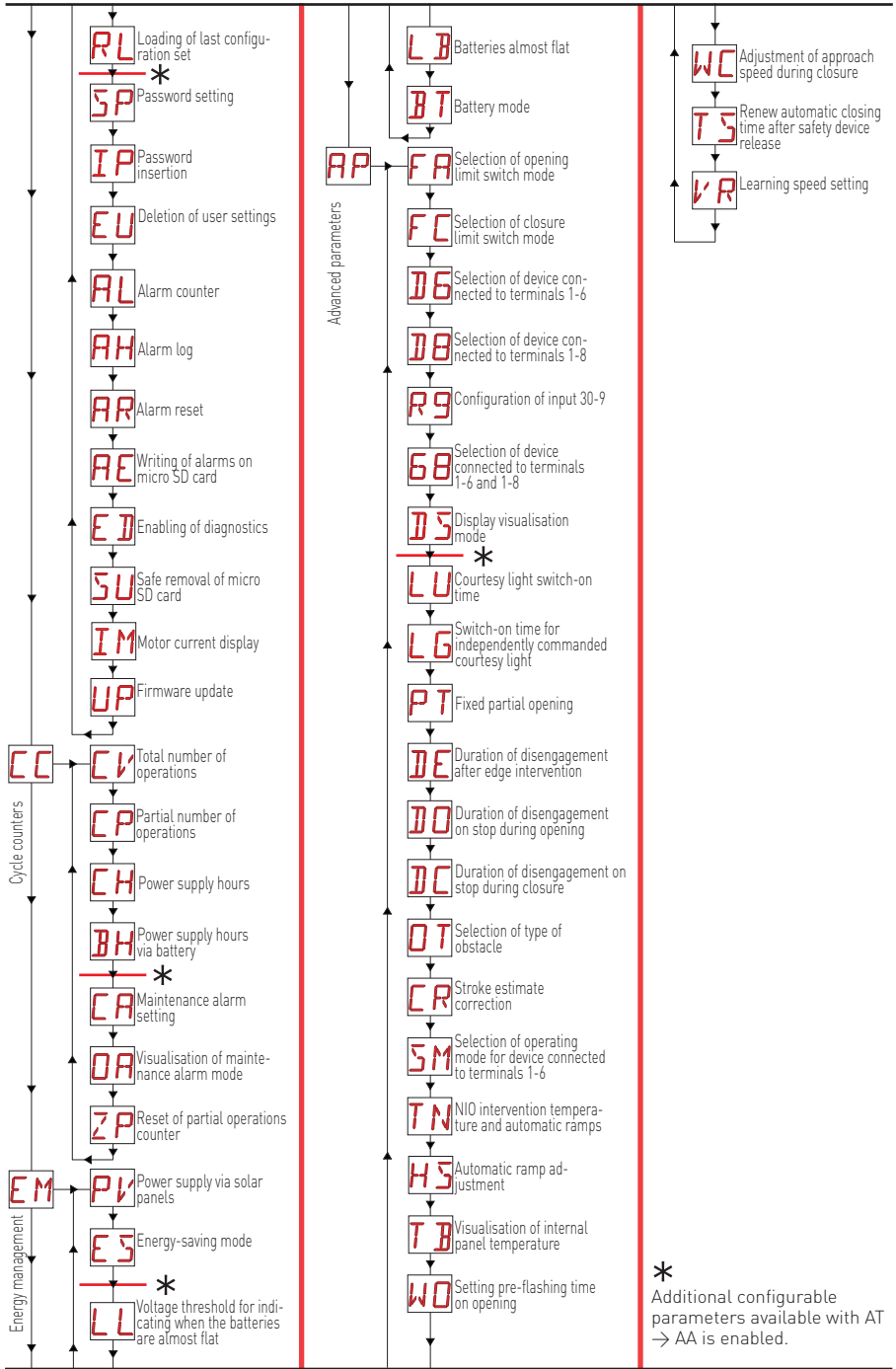

* Additional configurable parameters available with AT → AA is enabled.

6. Quick start-up sequences

6.1 Selection of automation type

Example of Obbi automation selection

Set



Example of PWR25 automation selection

Set



NB: if no automation is selected (alarm **M0** active) using the   keys, you can access the values of parameter **AS** directly

6.2 Configuration of the number of gate wings

Configuration example for a single gate wing

Set



6.3 Enabling the configurations

Step-by-step mode without automatic closure (residential use)



Step-by-step mode with automatic closure 1 min (residential use) [standard settings]



Opening mode with automatic closure 1 min (condominium use)



6.4 Adding remote controls



6.5 Configuration of the limit switches

Example 1 - Door wing stops against mechanical end stops (standard setting)

Set



Example 2 - Door wing stops against limit switches

Set



With these settings, if an obstacle is detected while the gate wing is opening, it stops with a disengagement operation; during closure, the gate wing reopens).

Example 3 - Door wing stops against mechanical end stops and reverses motion if an obstacle is detected

Set



With these settings, the gate wing stops against its respective mechanical closing end stop and the opening limit switch.

If an obstacle is detected during the opening and before the activation of the stop limit switch, the gate wing stops with a disengagement operation.

If an obstacle is detected during closure and before the activation of the proximity limit switch, the gate wing reopens; once the proximity limit switch has been activated, the gate wing stops against the obstacle.

6.6 Configuration of the safety devices

Example 1 - Configuration of the photocells connected to terminals 1-8 and 1-6 [standard settings]

Set



Example 2 - Configuration of the safety edge with safety test simultaneously connected to terminals 1-6 and 1-8

Set



7. Application examples

7.1 Automations with two swinging gates

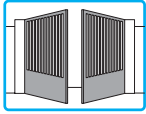

When the Entrematic LCU40H control panel is used in applications for automations with two overlapping swinging gate wings, the following connections can be made:

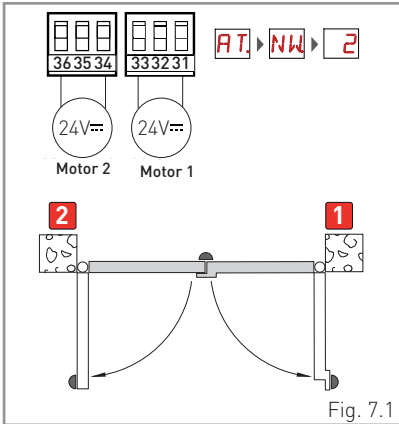

Fig. 7.1

(Fig. 7.1) Installation with mechanical end stops for opening and closure, and without the use of electric limit switches.

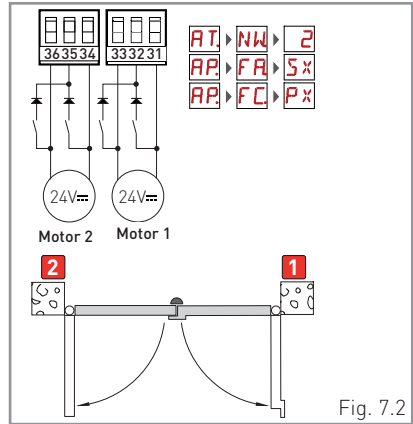
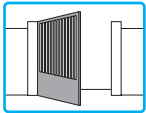

Fig. 7.2

(Fig. 7.2) Installation with mechanical end stop for closure, and with the use of electric limit switches (stop during opening and proximity during closure).

7.2 Automations with one swinging gate wing



When the Entrematic LCU40H control panel is used in applications for automations with one swinging gate wing, the following connections can be made:

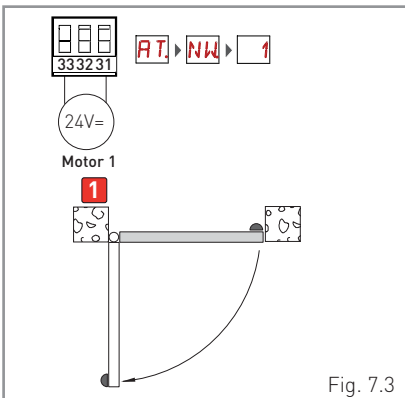

Fig. 7.3

(Fig. 7.3) Installation with mechanical end stops for opening and closure, and without the use of electric limit switches.

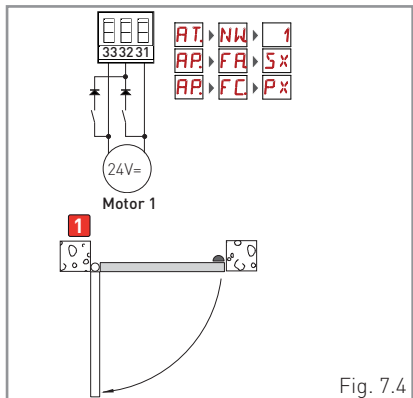
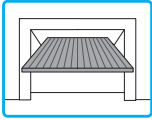

Fig. 7.4

(Fig. 7.4) Installation with mechanical end stop for closure, and with the use of electric limit switches (stop during opening and proximity during closure).

7.3 Up-and-over doors with two parallel motors



When the Entrematic LCU40H control panel is used in applications for automations with up-and-over doors with two parallel motors, the following connections can be made:

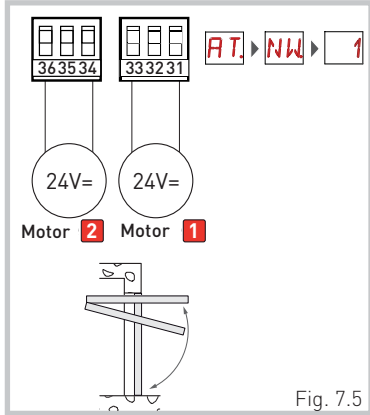

[Fig. 7.5] Installation with mechanical end stops for opening and closure, and without the use of electric limit switches.

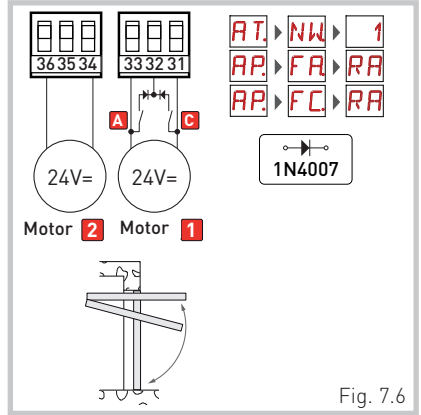

[Fig. 7.6] Installation with electric limit switches for deceleration during opening and closure.

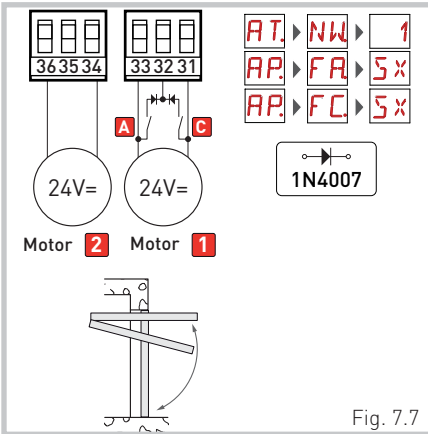

[Fig. 7.7] Installation with electric limit switches (stop during opening and closure).

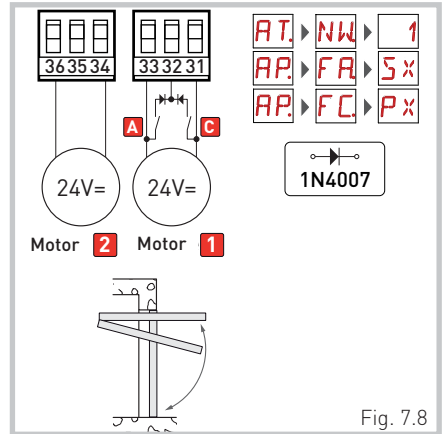

[Fig. 7.8] Installation with electric limit switches (stop during opening and proximity during closure).

8. Commands



You are advised to read paragraph 11 for all the details about the possible adjustments.



WARNING: terminal 30 [common positive for commands] has the same functions as terminal 1, so the commands visible on the display are indicated with 1-5, 1-3, 1-4, etc. It is different from terminal 1, however, because of the maximum current that can be dispensed and it is also active when the control panel is in standby **ES** → **ON**.

Command	Function	Description
30 2 NO	AUTOMATIC CLOSURE	The permanent closure of the contact enables automatic closure if AC → 1-2 .
30 3 NO	OPENING	When selecting BC → 35 → 1-3 , the closure of the contact activates an opening operation.
	STEP-BY-STEP	When selecting BC → 35 → 1-5 , the closure of the contact activates a sequential opening or closing operation: opening-stop-closing-opening. The "opening-stop-closing-opening" sequence can be changed to "opening-stop-closing-stop-opening" by selecting BC → PP .
30 4 NO	CLOSURE	The closure of the contact activates a closing operation.
30 5 NO	STEP-BY-STEP	When selecting BC → CS → 1-5 , the closure of the contact activates a sequential opening or closing operation: opening-stop-closing-opening. WARNING: if automatic closure is enabled, the duration of the stop can be defined by selecting BC → SS . The "opening-stop-closing-opening" sequence can be changed to "opening-stop-closing-stop-opening" by selecting BC → PP .
	OPENING	When selecting BC → CS → 1-3 , the closure of the contact activates an opening operation.
1 6 NC	SAFETY STOP	The opening of the safety contact stops and prevents any movement. NB: APSM to set different safety contact functions, see the → parameter settings.
1 8 NC	CLOSING SAFETY DEVICE	The opening of the safety contact triggers a reversal of the movement (reopening) during the closing operation. When selecting BC → SO → ON , the opening of the contact prevents any operation when the automation is idle. When selecting BC → SO → OF , the opening of the contact only prevents closure when the automation is idle.
1 6/8 NC	CLOSING/ OPENING SAFETY DEVICE	The opening of the safety contact stops and prevents any movement. NB: operation corresponds to that of contact 1-6 with AP → SM → OS .
30 9 NC	STOP	The opening of the safety contact causes the current operation to stop. If AP - R9 = 9P , automatic closure is disabled when contact 30-9 recloses. If AP - R9 = 9T , automatic closure remains enabled when contact 30-9 recloses.
30 9 NO	"OPERATOR PRESENT" COMMAND	When selecting AP → R9 → HR , the opening of contact 30-9 enables the "operator present" function: - opening with operator present 30-3 - closure with operator present 30-4 NB: any safety devices, automatic closure and plug-in board in the AUX housing are all disabled.
30 20 NO	PARTIAL OPENING	The closure of the contact activates a partial opening operation. Once the automation stops, the partial opening control performs the opposite operation to the one performed before the stop.



WARNING: make a jumper for all NC contacts if not used, or deactivate them via the relative menu. Terminals with the same number are equal.

8.1 Inserting plug-in boards (AUX)

To access the slots for plug-in boards (AUX):



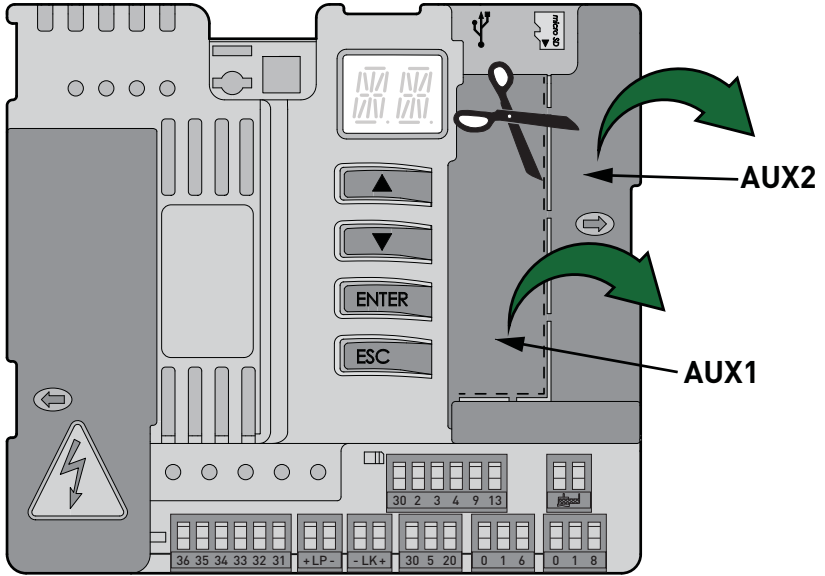

- If you want to insert just one board, cut the control panel cover and remove it as shown in the figure.
- If both slots are needed, remove the cover completely.





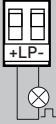
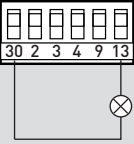
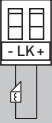

8.2 SOFA1-SOFA2 or GOPAVRS self-controlled safety edge

Command		Function	Description
		SAFETY TEST	Insert the SOFA1-SOFA2 or GOPAVRS device in the slot for plug-in boards AUX1 or AUX2. If the test fails, an alarm message appears on the display.
	NC	SAFETY STOP	When selecting AP → DB → S4I , connect the output contact of the safety device to terminals 1-6 on the control panel (in series with the photocell output contact, if installed).
	NC	CLOSING SAFETY DEVICE	When selecting AP → DB → S4I , connect the output contact of the safety device to terminals 1-8 on the control panel (in series with the photocell output contact, if installed).
	NC	CLOSING/ OPENING SAFETY DEVICE	When selecting AP → 6B → S4I , connect the output contact of the safety device to terminals 1-6-8 on the control panel (in series with the photocell output contact, if installed). If 6B → S4I , DB and DB cannot be P4I or S4I .



9. Outputs and accessories

Output	Value of accessories	Description
	24V $\overline{=}$ / 0.5 A	Power supply to accessories Output for power supply to external accessories. NB: the maximum absorption of 0.3A corresponds to the sum of all terminals 1. The "gate open" indicator light (30-13) is not calculated in the 0.3A indicated above. The maximum value to be considered is 3W.
	GOL148REA	If the GOL868R4 radio receiver is used (868.35 MHz), connect the supplied antenna wire (90mm).
	LAMPH $\overline{=}$ 24V / 25W	Flashing light The pre-flashing settings can be selected from the third level menu AP \rightarrow WO and/or AP \rightarrow WC . To modify the operating mode of the LP output, refer to the selection BA \rightarrow FF .
	$\overline{=}$ 24V / 3W	Automation status lamp For the operating mode of output 30-13, refer to the selection BC \rightarrow OL .
	12V- / 15W	Electric lock It is activated when the operation begins with the automation closed. To modify the operating mode of the LK output, refer to the selection BA \rightarrow EO .
AUX 1 AUX 2	SOFA1-SOFA2 GOPAVRS LAN4S LAB9 BIXLR12 BIXLR22 GOL868R4 BIXLR42 LAN7S	The control panel has two slots for plug-in command and safety boards. The action of the control board can be selected using BC \rightarrow AM for AUX1 and BC \rightarrow AN for AUX2. When using slot-in radio boards, remove the RDX module. The display will show RV . WARNING: the plug-in board must be inserted and removed with the power supply disconnected.
RDX 	6ZENRS ZENPRS	The control panel is fitted with a housing for modules of the 6ZENRS radio receiver type (433.92 MHz). Can be replaced with a radio receiver module of the ZENPRS type (868.35 MHz). The operating mode is selected via BC \rightarrow RM . When using slot-in radio boards, remove the RDX module. The display will show RV . WARNING: the modules must be inserted and removed with the power supply disconnected.

Output	Value of accessories	Description
	USB	The control panel is fitted with a USB input for connecting to a PC in order to update firmware files using AMIGO software (with a Standard-A plug, or Micro-B plug USB cable).
	MicroSD	The control panel manages microSD cards for updating the firmware and for diagnostics and configuration storage/recovery via the in commands SF → SV and SF → RC . NB: use a microSD with a maximum capacity no greater than 16 Gb.
	BIXM R2	COM - This allows the functioning configurations to be saved using the function SF → SV . The saved configurations can be recalled using the function SF → RC . COM - The storage module allows the remote controls to be stored. If the control panel is replaced, the storage module being used can be inserted in the new control panel. WARNING: the storage module must be inserted and removed with the power supply disconnected, and paying attention to the positioning direction.
	SBU	BAT - Battery-powered operation. The batteries are kept charged when the power supply is on. If the power supply is off, the panel is powered by the batteries until the power is re-establish or until the battery voltage drops below the safety threshold. The panel turns off in the last case. WARNING: the batteries must always be connected to the control panel for charging. Periodically check the efficiency of the batteries. NB: the operating temperature of the rechargeable batteries is from +5°C to +40°C. For advanced control of battery-powered operation, refer to the menu EM .

10. Jumper setting

Jumper	Description	OFF	ON
JR1	Display mode selection	Display mode. Only the values and parameters present can be displayed.	Maintenance mode. Only the values and parameters present can be displayed and modified. Activated maintenance mode is indicated by the permanent switching on of the right-hand point on the display.

Jumper	Description		
AUX1	Selection of power supply - auxiliary board 1	AUX1 powered from 0-1.	AUX1 powered from 0-30.
AUX2	Selection of power supply - auxiliary board 2	AUX2 powered from 0-1.	AUX2 powered from 0-30.

11. Adjustments





NB: depending on the type of automation and control panel, some menus may not be available.

11.1 Main menu

Display	Description
AT	AT - Automatic Configurations. The menu allows you to manage the automatic configurations of the control panel.
BC	BC - Basic Configurations. The menu allows you to display and modify the main settings of the control panel.
BA	BA - Basic Adjustments. The menu allows you to display and modify the main adjustments of the control panel. NB: some settings require at least three operations before they are set correctly.
RO	RO - Radio Operations. The menu is used to manage the radio functions of the control panel (alarm management, diagnostics enabling, FW updating).
SF	SF - Special Functions. The menu allows you to set the password and manage the special functions in the control panel.
CC	CC - Cycles Counter. The menu allows you to display the number of operations carried out by the automation and manage the maintenance interventions.
EM	EM - Energy Management. The menu allows you to display and modify the energy saving settings and adjustments (Green Mode and battery management).
AP	AP - Advanced Parameters. The menu allows you to display and modify the advanced settings and adjustments of the control panel (limit switch mode, selection of devices connected to the terminals, disengagement duration adjustments, flashing light adjustments, etc.). NB: some settings require at least three operations before they are set correctly.

From the main menu you can access the second level menu as follows:

- use the  and  keys to select the required function
- press  to confirm



After confirming the selection, you access the second level menu.

For each function of the main menu, there are also additional configurations that can be viewed by enabling the **AA** function (see the following paragraph).



NB: to check if the parameters have actually been modified, quit the relative parameter and then access it again.
The modifications will take effect from the next operation.

11.2 Second level menu - AT (Automatic Configurations)

Display	Description	Selections available	
AS	AS - Automation selection This selection pre-sets the type of motor and a sub-set of parameters linked to the kinematic mechanism of the automation for a standard installation. See "Selection of automation type", paragraph 11.3. Each parameter can still be modified when necessary.	<u>NO</u>	17
NW	NW - Selection of the number of gate wings In the case of automations with a single gate wing, connect motor 1.	0	<u>102</u>
H0	H0 - Predefined setting, residential use 0 This selection loads predefined values for certain standard parameters: AC - enabling of automatic closing : 1-2 C5 - step-by-step/opening command operation : step-by-step RM - remote control operation : step-by-step AM - AUX plug-in board operation : step-by-step SS - Selection of automation status at start-up : open		
H1	H1 - Predefined setting, residential use 1 This selection loads predefined values for certain standard parameters: AC - enabling of automatic closing : enabled TC - setting of automatic closing time : 1 minute C5 - step-by-step/opening command operation : step-by-step RM - remote control operation : step-by-step AM - AUX plug-in board operation : step-by-step SS - Selection of automation status at start-up : closed		
C0	C0 - Predefined setting, condominium use 0 This selection loads predefined values for certain standard parameters: AC - Enabling of automatic closure : enabled TC - setting of automatic closing time : 1 minute C5 - step-by-step/opening command operation : Opening RM - remote control operation : Opening AM - AUX plug-in board operation : Opening SS - Selection of automation status at start-up : closed		
RD	RD - Resetting of general settings (SETTINGS RESET)  02" 02"		
AA	AA - Activation of additional configurable parameters for each function of the main menu.  02"		AAAD
	After activation you can scroll through the third level menus. The third level menus are activated for 30 min.		

AT - Automatic configurations

11.2.1 Selection of automation type **AT** → **AS** and specific default settings

AS Type of automation	Model	CM Motor circuit	R1-R2 Thrust on obstacles and current	VA - VC Speed during opening and closure	VR Learning speed	PO-PC Approach speed	TA Acceleration time during opening	TQ Acceleration time during closure	VM Ramp start-up speed
01	OBBI3BH	CL	50	24	18	07	2	3	03
02	ARCBH		70	14	10	06	2	3	03
03	FACIL3H		50	12	10	05	2	3	03
04	LUX03BH-4BH		40	16	12	06	1	2	10
05	LUX05BH (normal gate wing)	OP	40	15	10	06	1	2	10
06	LUX05BH (long gate wing)		50	12	08	05	1	2	10
07	ARC1BH (normal gate wing)	CL	50	08	06	05	2	3	03
08	ARC1BH (long gate wing)		60	06	05	04	2	3	03
09	DOR1BH (normal gate wing)		50	08	06	05	2	4	03
10	DOR1BH (long gate wing)		60	06	05	04	3	6	02
11	CUBIC6H-30H		60	12	08	06	2	3	05
12	BOX3SH		50	10	06	05	1	5	03
13	DOKE	OP	50	15	08	05	1	1	03
14	PWR25H	CL	50	18	10	05	2	3	03
15	PWR35H		50	20	12	06	2	3	03
16	PWR50H (normal gate wing)	OP	40	15	10	06	1	2	10
17	PWR50H (long gate wing)		50	12	8	05	1	2	10

11.3 Second level menu - BC (Basic Configurations)

BC - Basic configurations	Display	Description	Selections available
	AC	AC - Enabling of automatic closure ON - Enabled 1-2 - Dependent on input 30-2	ON1-2 <u> </u>
	SS	SS - Selection of automation status at start OP - Open CL - Closed Indicates how the control panel considers the automation at the time of switch-on, or after a POWER RESET command.	OP CL <u> </u>
	SO	SO - Enabling of reversal safety contact functioning ON - Enabled OF - Disabled When enabled (ON) with the automation idle, if the contact 1-8 is open, all operations are prevented. When disabled (OF) with the automation idle, if the contact 1-8 is open, opening operations are permitted.	ON <u> </u> OF
	NI	NI - Enabling of NIO electronic anti-freeze system ON - Enabled OF - Disabled When enabled (ON), it maintains the efficiency of the motor even at low ambient temperatures. NB: for correct operation, the control panel must be exposed to the same ambient temperature as the motors. The intervention temperature for NIO can be set by selecting <i>AP</i> → <i>TN</i> .	ON <u> </u> OF <u> </u>

11.3.1 Additional BC level parameters that can be configured (available with *AT* → *AA* enabled)

BC	Display	Description	Selections available
	CS	C5 - Operation of command associated with contact 30-5 1-5 - Step-by-step 1-3 - Opening	1-51-3 <u> </u>
	3S	3S - Operation of command associated with contact 30-3 1-5 - Step-by-step 1-3 - Opening	1-31-5 <u> </u>
	RM	RM - Radio receiver operation 1-5 - Step-by-step 1-3 - Opening	1-51-3 <u> </u>
	AM	AM - Operation of AUX1 plug-in control board 1-5 - Step-by-step 1-3 - Opening	1-51-3 <u> </u>
	AN	AN - Operation of AUX2 plug-in control board 1-5 - Step-by-step 1-3 - Opening	1-51-3 <u> </u>
MP	MP - Start-up at maximum power ON - During start-up it increases the thrust on obstacles to maximum OFF - During start-up, the thrust on obstacles is at the level adjusted by <i>R 1 - R2</i>	ON OF <u> </u>	

Display	Description	Selections available
PP	PP - Setting step-by-step sequence from command 30-5 ON - Opening-Stop-Closing-Stop-Opening OF - Opening-Stop-Closing-Opening	ON OF <u>OF</u>
SS	S5 - Duration of STOP in step-by-step sequence from command 30-5 ON - Permanent OF - Temporary	ON OF <u>OF</u>
VS	VS - Checking the mechanical end stops When enabled (ON), every time the power supply is connected the automation automatically checks the mechanical stops and/or stop limit switches during opening and closing at the speed set with the adjustment AP → VR . During the learning operation, the display shows the message MQ and the closing operation involves one gate wing at a time (1C).	ON <u>ON</u> OF <u>OF</u>
CM	CM - Motor circuit with automation idle CL - with the automation idle, the motor is kept in short-circuit OP - with the automation idle, the motor is kept open In the case of a reversible automation, set CM → OP to allow the motor to rotate freely.	CL OP <u>CL OP</u> See paragraph 11.2.1

11.4 Second level menu - BA (Basic Adjustment)

Display	Description	Selections available
TC	TC - Setting of automatic closing time [s] It is set with different intervals of sensitivity. • from 0" to 59" with intervals of 1 second • from 1' to 2' with intervals of 10 seconds	00 59 1' 2' <u>1'00"</u>
RP	RP - Adjustment of partial opening measurement [%] Adjusts the percentage of operation in relation to the total opening of the automation. Partial opening is performed on gate wing 1. 10 - Minimum 99 - Maximum	10 99 <u>50</u>
TP	TP - Setting of automatic closing time after partial opening [s] It is set with different intervals of sensitivity. • from 0" to 59" with intervals of 1 second • from 1' to 2' with intervals of 10 seconds.	00 59 1' 2' <u>30</u>
VA	VA - Opening speed [V] NB: MAX = 20 for: LUX05BH ARC1BH DOR1BH CUBIC6H-30H BOX3SH DOKE POWER 50H	04 27 <u>See paragraph 11.2.1</u>

BA - Basic adjustment



Display	Description	Selections available
	<p>VC - Closing speed [V] NB: MAX = 20 for: LUX05BH ARC1BH DOR1BH CUBIC6H-30H BOX3SH DOKE POWER 50H</p>	<p></p> <p>See paragraph 11.2.1</p>
	<p>R1 - Adjustment of thrust on obstacles and current - motor 1 [%] The control panel is fitted with a safety device which, when it detects an obstacle: - stops the opening movement and, if outside the limit area for detecting obstacles, performs a disengagement operation whose duration can be set with AP → JE ; - reverses the movement during closure operations outside the limit area for detecting obstacles; - stops the movement during closure operations within the limit area for detecting obstacles.</p> <p>The limit area for detecting obstacles during opening and closing is determined by the type of limit switch installed. If there is no limit switch, it is determined on the basis of the selections BA → 00 and BA → 0C . 00 - Minimum thrust 99 - Maximum thrust</p>	<p></p> <p>See paragraph 11.2.1</p>
	<p>R2 - Adjustment of thrust on obstacles and current - motor 2 [%] The control panel is fitted with a safety device which, when it detects an obstacle: - stops the opening movement and, if outside the limit area for detecting obstacles, performs a disengagement operation whose duration can be set with AP → JE ; - reverses the movement during closure operations outside the limit area for detecting obstacles; - stops the movement during closure operations within the limit area for detecting obstacles.</p> <p>The limit area for detecting obstacles during opening and closing is determined by the type of limit switch installed. If there is no limit switch, it is determined on the basis of the selections BA → 00 and BA → 0C . 00 - Minimum thrust 99 - Maximum thrust</p>	<p></p> <p>See paragraph 11.2.1</p>
	<p>TR - Motor delay time [s] Delay time for closure of gate wing 1 in relation to gate wing 2. 00-30 s</p>	<p></p>



NB: make adjustments gradually and only after performing at least three complete operations to allow the control panel to be set correctly and detect any friction during operations.

11.4.1 Additional BA level parameters that can be configured (available with **AT** → **AA** enabled)

Display	Description	Selections available
DT	DT - Adjustment of obstacle recognition time [s/100] 10 - Minimum 60 - Maximum NB: the parameter is adjusted in hundredths of a second.	10 60 <u>20</u>
ST	ST - Adjustment of start time [s] 0.5 - Minimum 3.0 - Maximum	0.5 3.0 <u>2.0</u>
TA	TA - Adjustment of acceleration time during opening [s] 0.5 - Minimum 9.9 - Maximum	0.5 9.9 See paragraph 11.2.1
TQ	TQ - Adjustment of acceleration time during closure [s] 0.5 - Minimum 9.9 - Maximum	0.5 9.9 See paragraph 11.2.1
VM	VM - Initial movement speed [V] 00 - Minimum 15 - Maximum	00 15 See paragraph 11.2.1
TD	TD - Adjustment of deceleration time [%] Adjusts the deceleration ramp slope 10 - Minimum 99 - Maximum	10 99 <u>50</u>
OB	OB - Setting of deceleration time during opening [s] Indicates the time between the start of the deceleration ramp and the end of the opening stroke 00 - Minimum 30 - Maximum	00 30 <u>10</u>
CB	CB - Setting of deceleration time during closing [s] Indicates the time between the start of the deceleration ramp and the end of the closing stroke 00 - Minimum 30 - Maximum	00 30 <u>10</u>
PO	PO - Adjustment of approach speed during opening [V] Indicates the speed from the end of the deceleration ramp to the end of the opening stroke 03 - Minimum 10 - Maximum NB: gradually increase the approach speed if there is a series of quick vibrations (chattering) in heavy gates installed with a slight incline.	03 10 See paragraph 11.2.1
PC	PC - Adjustment of approach speed during closing [V] Indicates the speed from the end of the deceleration ramp to the end of the closing stroke. 03 - Minimum 10 - Maximum	03 10 See paragraph 11.2.1
OO	OO - Obstacle detection limit during opening [%] Indicates the percentage of the distance travelled during BA → OB or after the detection of the opening limit switch AP → FA → RA on which the disengagement is deactivated. NB: not active if AP → FA → Sx or if AP → FA → Px .	05 99 <u>99</u>

Display	Description	Selections available
OC	OC - Obstacle detection limit during closure [%] Indicates the percentage of the distance travelled during $BA \rightarrow C$ or after the detection of the closing limit switch $AP \rightarrow FC \rightarrow RA$ on which the reversal is deactivated. NB: not active if $AP \rightarrow FC \rightarrow SX$ and if $AP \rightarrow FC \rightarrow PX$.	0599 99
TO	TO - Setting motor 2 opening delay time [s] Adjustment, in seconds, of the delay time for starting the operation of motor 2, in relation to motor 1.	0030 03
LR	LR - Electric lock release time [s] If enabled, this indicates the electric lock activation time at the start of every opening operation with the automation closed.	0.52.5 1.5
M1	M1 - Operation time - motor 1 [s] Adjustment, in seconds, of the total operation time for motor 1.  WARNING: it is set with a sensitivity interval of 0.5 s, shown when the decimal point on the right lights up. Example: $\boxed{07}$ = 7 seconds / $\boxed{07}$ = 7.5 seconds NB: the setting of M1 is only active with $BC \rightarrow VS \rightarrow OF$.	0260 10
M2	M2 - Operation time - motor 2 [s] Adjustment, in seconds, of the total operation time for motor 1.  WARNING: it is set with a sensitivity interval of 0.5 s, shown when the decimal point on the right lights up. Example: $\boxed{07}$ = 7 seconds / $\boxed{07}$ = 7.5 seconds NB: the setting of M2 is only active with $BC \rightarrow VS \rightarrow OF$.	0260 10
EO	EO - Function of output -LK+ 00 - courtesy light 01 - electric lock 02 - electric lock + release stroke 03 - output active with automation closed (for electromagnets of the fail-safe type) 04 - output active with automation open 05 - output active with automation moving (can also be used for electromagnets that need to be powered throughout the operation) 06 - output active with automation opening 07 - output active with automation closing 08 - output active with maintenance alarm triggered 09 - output active for indicating batteries almost flat 10 - ON-OFF flashing light for LED without oscillator 11 - ON-OFF flashing light ON - output always active	
FF	FF - Function of output +LP- 00 - courtesy light 01 - ON-OFF flashing light 02 - fixed light (at 230V AC, or LED with internal oscillator) 03 - output active with automation closed 04 - output active with automation open 05 - output active with automation moving 06 - output active with automation opening 07 - output active with automation closing 08 - output active with maintenance alarm triggered 09 - output active for indicating batteries almost flat 10 - ON-OFF flashing light for LED without oscillator 11 - electric lock 12 - electric lock + release stroke ON - output always active	

Display	Description
BA OL	OL - Indicator light for automation open
	00 - proportional flashing depending on the point where the gate wings are positioned and the operation direction (in battery mode, the flashing is different)
	01 - fixed ON (automation not closed)
	02 - output active with automation not open
	03 - output active with automation closed
	04 - output active with automation open
	05 - output active with automation moving
	06 - output active with automation opening
	07 - output active with automation closing
	08 - output active with maintenance alarm triggered
	09 - output active for indicating batteries almost flat
ON - output always active	

i NB: make adjustments gradually and only after performing at least three complete operations to allow the control panel to be set correctly and detect any friction during operations.

11.5 Second level menu - RO (Radio Operations)

Display	Description																
RO - Radio operations SR	SR - Remote control storage You can directly access the Remote control storage menu even with the display turned off, but only with the Display visualisation mode option set to 00 or 03: - for transmitting a remote control not present in the memory; - for transmitting an unstored channel of a remote control already present in the memory.																
	WARNING: if the display shows NO flashing, the remote control may already be stored.																
TX	TX - Visualisation of counter showing remote controls stored 																
MU	<table border="1"> <thead> <tr> <th colspan="2">MU - Indication of maximum number of remote controls that can be stored in the integrated memory</th> <th colspan="2">Selections available</th> </tr> </thead> <tbody> <tr> <td colspan="4">You can store a maximum of 100 or 200 remote control codes.</td> </tr> <tr> <td colspan="2"> </td> <td>20</td> <td>10</td> </tr> <tr> <td colspan="2"> 20 - 200 remote controls that can be stored 10 - 100 remote controls that can be stored </td> <td colspan="2"> <hr style="width: 50%; margin-left: auto; margin-right: 0;"/> </td> </tr> </tbody> </table>	MU - Indication of maximum number of remote controls that can be stored in the integrated memory		Selections available		You can store a maximum of 100 or 200 remote control codes.						20	10	20 - 200 remote controls that can be stored 10 - 100 remote controls that can be stored		<hr style="width: 50%; margin-left: auto; margin-right: 0;"/>	
MU - Indication of maximum number of remote controls that can be stored in the integrated memory		Selections available															
You can store a maximum of 100 or 200 remote control codes.																	
		20	10														
20 - 200 remote controls that can be stored 10 - 100 remote controls that can be stored		<hr style="width: 50%; margin-left: auto; margin-right: 0;"/>															



WARNING: selecting **MU** → **20** (200 remote controls), the configurations **U 1** and **U 2** saved with the **SF** → **SV** command will be lost. This also applies for the last configuration reloaded with **RL**. In addition, new configurations cannot be saved on **U 1** and **U 2**.

RO - Radio operations

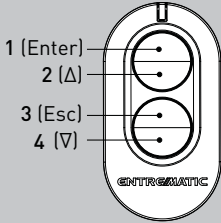
Display	Description	Selections available
RK	<p>RK - Menu navigation using remote control keyboard ON - Enabled OF - Disabled</p> <p>With the display turned off, quickly type in the sequence of keys ③ ③ ② ④ ① from the stored remote control you want to use. Make sure all the CH keys are stored. WARNING: during navigation with a remote control keyboard ALL the stored remote controls are inactive.</p>  <p>To make viewing and adjustment easier (avoiding the need to continuously press the remote control), press the UP ↑ or DOWN ↓ key once to begin slowly scrolling through the parameters. This scrolling movement is faster if the UP ↑ or DOWN ↓ key is pressed twice. To stop the scrolling, press ENTER. To confirm your choice of parameter, press ENTER again. To test any new setting, switch off the display and issue an opening command using key ③. Navigation using a remote control keyboard is automatically disabled after 4 minutes of inactivity or by setting RK → OF.</p>	<p>ON</p> <p>OF</p>

11.5.1 Additional RO level parameters that can be configured (available with **AT** → **AA** enabled)

Display	Description	Selections available
[1]	<p>C1, C2, C3, C4 - Selection of CH1, CH2, CH3, CH4 function of stored remote control. NO - No setting selected 1-3 - Opening command 1-4 - Closing command 1-5 - Step-by-step command P3 - Partial opening command LG - Command to switch the courtesy light on/off 1-9 - STOP command</p> <p>If even just one (any) CH key of the remote control is stored, the opening or step-by-step command is implemented. NB: the 1-3 (opening) and 1-5 (step-by-step) options are available as alternatives, and depend on the selection BC → RM.</p> <p>If 2-4 CH keys of a single remote control are stored, the functions matched in the factory with the CH keys are as follows:</p> <ul style="list-style-type: none"> • CH1 = opening/step-by-step command • CH2 = partial opening command; • CH3 = courtesy light on/off command • CH4 = STOP command. 	<p>NO</p> <p>1-3</p> <p>1-4</p> <p>1-5</p> <p>P3</p> <p>LG</p> <p>1-9</p>
[2]		
[3]		
[4]		







Display	Description	Selections available
RO	ER - Deletion of a single remote control 	
	EA - Total memory deletion 	
	RE - Setting memory opening from remote control OF - Disabled ON - Enabled When enabled (ON), the remote programming is activated. To store new remote controls without using the control panel, refer to the remote control instructions. NB: make sure you do not accidentally memorise unwanted remote controls.	ON OF
	EP - Setting the coded area messages If the possibility to receive coded messages is enabled, the control panel will be compatible with remote controls of the "ENCRYPTED" type.	ON OF

11.6 Second level menu - SF (Special Functions)

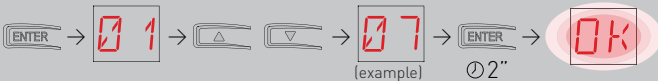
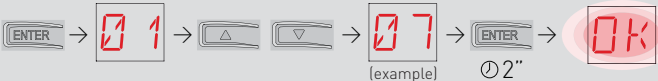
Display	Description	Selections available
SF - Special functions	CU - Visualisation of the firmware version on the control panel 	
	SV - Saving user configuration on control panel storage module and/or on microSD card <p>By selecting RO → MU → 10 you can save up to 2 personalised configurations in memory positions U 1 and U 2 only with the storage module present on the control panel.</p> <p>With a microSD on the control panel, up to 2 personalised configurations can be saved in positions D 1 and D 2.</p> <p>WARNING: if RO → MU → 20 is selected, no user configuration can be saved on U 1 and U 2.</p> <p>WARNING: if the display shows NO flashing, the storage module or microSD card may not be present.</p>	U 1 U 2 D 1 D 2
	RC - Configuration loading <p>The user configurations saved previously can be loaded - U 1 and U 2 on the storage module of the control panel, or D 1 and D 2 on the microSD card.</p>	U 1 U 2 D 1 D 2

Display	Description
SF - Special functions RL	RL - Loading of last configuration set  <p>⌀2"</p> <p>The control panel automatically saves the last configuration set, and keeps it memorised in the storage module or microSD card.</p> <p>In the event of a fault or the replacement of the control panel, the last configuration of the automation can be restored by inserting the storage module or microSD card and loading the configuration in question.</p>

11.6.1 Additional SF level parameters that can be configured (available with **AT** → **AA** enabled)

Display	Description
SF SP IP EU AL AH	SP - Setting the password  <p>⌀2"</p> <p>NB: this can only be selected when the password is not set.</p> <p>Setting the password prevents unauthorised personnel from accessing selections and adjustments.</p> <p>You can delete the set password by selecting the sequence JR1=ON, JR1=OFF, JR1=ON.</p>
	IP - Inserting the password  <p>⌀2"</p> <p>NB: this can only be selected when the password is set.</p> <p>When the password is not inserted, you can access the display mode regardless of the selection made with JR1.</p> <p>When the password is inserted, you can access in maintenance mode.</p>
	EU - Deletion of user configurations and last configuration set in the storage module  <p>⌀2" ⌀2"</p>
	AL - Alarm counter <p>Used to view, in sequence, the counters of alarms that have been triggered at least once (alarm code + number of times triggered).</p> <p>With  and , you can scroll through all the counters and see all the alarms recorded.</p>
	AH - Alarm log <p>Used to view, in sequence, alarms that have been triggered (maximum 20).</p> <p>With  and , you can scroll through the entire alarm log.</p> <p>The display shows the alarm number and code, alternated.</p> <p>The highest number corresponds to the most recent alarm and the lowest number (0) corresponds to the oldest alarm.</p>

Display	Description
SF	AR - Alarm reset Resets all the alarms in the memory (counters and log). NB: when the installation has been completed, you are advised to delete the alarms in order to facilitate future checks.
	AE - Writing of alarms on microSD card Creates a text file on the microSD memory, containing some information about the control panel: the firmware version, operation counters, hour counters, configuration parameters, alarms. NB: the alarm counters and alarm log are associated with the number of the operation that was in progress when they were triggered.
	ED - Enabling of diagnostics Enables the periodic saving of data on the micro SD card, for diagnostic use. NO - Disabled 01 - Internal use (DO NOT USE) 02 - List of events on microSD card
	SU - Safe removal of the microSD card
	IM - Motor current visualisation Selecting M1 , the display will show the current absorbed by motor 1. Selecting M2 , the display will show the current absorbed by motor 2.
	UP - Firmware update Activates the card bootloader in order to update the firmware.

11.7 Second level menu - CC (Cycles Counter)

Display	Description
CC - Cycles counter	CV - Display of total operations counter → 182 operations (example)
	CP - Display of partial operations counter → 716 operations (example)
	CH - Display of power supply hour counter → 256 power supply hours (example)
	BH - Visualisation of counter for power supply hours via battery → 215 operating hours via battery (example)

11.8.1 Additional EM level parameters that can be configured (available with **AT** → **AA** enabled)

Display	Description	Selections available
EM	LL - Voltage threshold for indicating that batteries are almost flat (V) 17 - Minimum 24 - Maximum NB: it is set with an interval of sensitivity of 0.5 V shown when the decimal point on the right lights up.	
	LB - Indication that batteries are almost flat 00 - Visualisation on display (alarm message B0) 01 - Visualisation on flashing light (with the automation idle, 2 flashes are made and then repeated every hour) and on display (alarm message B0) 02 - Visualisation on "open gate" indicator light (with the automation closed, 2 flashes are made and then repeated every hour) and on display (alarm message B0)	
	BT - Battery mode 00 - Anti-panic (performs the opening operation following a mains supply failure. The automation opens but does not accept any other commands until the mains supply has been restored). 01 - Continuous operation - the last operation performed before control panel switch-off will be an opening. 02 - Continuous operation - the last operation performed before control panel switch-off will be a closure.	

11.9 Second level menu - AP (Advanced Parameters)

Display	Description	Selections available
AP - Advanced parameters	FA - Selection of opening limit switch mode NO - None SX - Stop limit switch (after activation, the gate wing stops its movement) PX - Proximity limit switch (after activation, the gate wing continues as far as the end stop and any obstacle is considered a stop) RA - Deceleration limit switch (after activation, the gate wing slows down its movement)	
	FC - Selection of closing limit switch mode NO - None SX - Stop limit switch (after activation, the gate wing stops its movement) PX - Proximity limit switch (after activation, the gate wing continues as far as the end stop and any obstacle is considered a stop) RA - Deceleration limit switch (after activation, the gate wing slows down its movement)	
	D6 - Selection of device connected to terminals 1-6 NO - None SE - Safety edge (if contact 1-6 opens, there is a disengagement of 10cm after the stop) S41 - Safety edge with safety test (if contact 1-6 opens, after the stop there is a disengagement of a duration depending on the selection AP → JE) PH - Photocells P41 - Photocells with safety test	

AP - Advanced parameters

Display	Description	Selections available
D8	D8 - Selection of device connected to terminals 1-8 NO - None SE - Safety edge S41 - Safety edge with safety test PH - Photocells P41 - Photocells with safety test	NO SE S41 PH P41
R9	R9 - Configuration of input 30-9 NO - Disabled 9P - The opening of the input causes a permanent stop 9T - The opening of the input causes a temporary stop. When the contact closes, the automatic closure time is activated (if enabled) HR - With the input open, the automation operates in "operator present" mode	NO 9T 9P HR
68	68 - Selection of the device simultaneously connected to terminals 1-6 and 1-8 NO - None SE - Safety edge S41 - Safety edge with safety test If different from NO, the simultaneous opening of inputs 1-6 and 1-8 causes: - movement stop and reversal during a closing operation - movement stop and disengagement of a duration depending on the selection AP → DE during an opening operation	NO SE S41
DS	DS - Setting of display visualisation mode 00 - No visualisation 01 - Commands and safety devices with radiotest (see paragraph 9.2) Display of countdown to automatic closing 02 - Automation status (see paragraph 13.1) 03 - Commands and safety devices (see paragraph 13.2) NB: the setting 01 allows you to see when a radio transmission is received, for range checks.	00 01 02 03



NB: make adjustments gradually and only after performing at least three complete operations to allow the control panel to be set correctly and detect any friction during operations.

11.9.1 Additional AP level parameters that can be configured (available with **AT** → **AA** enabled)

Display	Description	Selections available
AP	<p>LU - Setting the courtesy light switch-on time (s) To enable this parameter, set at least one of the selections BA → EO or BA → FF as a courtesy light. It is set with different intervals of sensitivity.</p> <p>NO - Disabled - from 01" to 59" with intervals of 1 second - from 1' to 2' with intervals of 10 seconds - from 2' to 3' with intervals of 1 minute ON - Permanently enabled (switched off via remote control)</p> <p>NB: the courtesy light switches on at the start of each operation.</p>	<p>NO</p> <p>0 159</p> <p>1' ▶ 2'</p> <p>2' ▶ 3'</p> <p>ON</p>
	<p>LG - Switch-on time for independently commanded courtesy light [s] To enable this parameter, set at least one of the selections BA → EO or BA → FF as a courtesy light. It is set with different intervals of sensitivity.</p> <p>NO - Disabled - from 01" to 59" with intervals of 1 second - from 1' to 2' with intervals of 10 seconds - from 2' to 3' with intervals of 1 minute ON - Switched on and off with remote control</p> <p>NB: the switching on of the light does not depend on the start of an operation, but can be commanded separately using the special remote control key.</p>	<p>NO</p> <p>0 159</p> <p>1' ▶ 2'</p> <p>2' ▶ 3'</p> <p>ON</p>
	<p>PT - Fixed partial opening ON - Enabled OF - Disabled If ON, a partial opening command given on the partial opening position is ignored. With contact 30-20 closed (for example with the timer or manual selector), the gate will partially open. If it is then fully opened (command 30-3) and reclosed (even with automatic closing), it will stop at the partial opening position.</p>	<p>ON OF</p>
	<p>DE - Disengagement duration if an edge is triggered [s] Regulates the duration of the disengagement when an edge (active or passive) is triggered during opening or closure. In the case of gates with two wings, it acts on both wings. 00 - Deactivated</p>	<p>0.0 ▶ 2.0</p> <p>1.0</p>
	<p>DO - Duration of disengagement on stop during opening [s/100] Regulates the duration of the disengagement on the mechanical opening stop. 00 - Disabled 99 - Maximum NB: not active if FA → SX</p>	<p>00 ▶ 99</p>
<p>DC - Duration of disengagement on stop during closure [s/100] Regulates the duration of the disengagement on the mechanical opening stop. 00 - Disabled 99 - Maximum NB: not active if FC → SX</p>	<p>00 ▶ 99</p>	

Display	Description	Selections available
OT	OT - Selection of type of obstacle 00 - Overcurrent or gate stopped 01 - Overcurrent 02 - Door stopped	00 01 02 <u>01</u>
CR	CR - Stroke estimate correction [%] DO NOT USE (diagnostic purposes only)	-- 9+9
SM	SM - Selection of operating mode of device connected to terminals 1-6 00 - During the operation, the opening of the safety contact stops the movement (with disengagement if DB → SE / S4). 01 - During the operation, the opening of the safety contact stops the movement (with disengagement if DB → SE / S4). When the contact closes again, the interrupted operation is resumed. 02 - During the operation, the opening of the safety contact stops the movement (with disengagement if DB → SE / S4). When the contact closes again, an opening operation is performed. 03 - During the closing operation, the opening of the safety contact reverses the movement. During the opening operation, the safety device is ignored. 04 - During the opening operation, the opening of the safety contact stops the movement (with disengagement if DB → SE / S4). When the contact closes again, the interrupted opening operation is resumed. During the closing operation, the safety device is ignored. 05 - During the closing operation, the opening of the safety contact stops and reverses the movement. During the opening operation, the opening of the safety contact stops the movement (with disengagement if DB → SE / S4).	00 01 <u>00</u> 02 03 04 05
TN	TN - Setting of intervention temperature for NIO electronic anti-freeze system and automatic HS ramps [°C] This value does not refer to the ambient temperature, but to the internal control panel temperature.	-- 950 <u>10</u>
HS	HS - Automatic ramp adjustment ON - Enabled OF - Disabled When enabled (ON), at low ambient temperatures the start time ST increases up to the maximum value and the acceleration time TA and TQ diminishes to the minimum value. NB: for correct operation, the control panel must be exposed to the same ambient temperature as the motors. The intervention temperature can be set via the selection AP → TN .	ON OF <u>OF</u>
TB	TB - Permanent display of the internal control panel temperature [°C]	ON OF <u>OF</u>
WO	WO - Setting of pre-flashing time on opening [s] Adjustment of the lead time for the switch-on of the flashing light, in relation to the start of the opening operation from a voluntary command. 00 - Minimum 05 - Maximum	00 05 <u>00</u>

Display	Description	Selections available
AP WC	WC - Setting of pre-flashing time on closing [s] Adjustment of the lead time for the switch-on of the flashing light, in relation to the start of the closing operation from a voluntary command. 00 - Minimum 05 - Maximum	0005 <u>00''</u>
	TS - Setting of renewal of automatic closing time after safety device release [%] 00 - Minimum 99 - Maximum	0099 <u>99</u>
	VR - Setting of learning speed [V]	0420 <u>See paragraph 11.2.1</u>

12. Diagnostics



12.1 Data Logging integrated in the board

The Entrematic LCU40H control panel is equipped with an internal system that allows the installer to check whether any alarms have been triggered, how many times, and the log of the last twenty alarms.

12.1.1 Alarm counter

With the third level menus enabled (**AT** → **AA**), go to **SF** → **AL** to see all the alarms recorded by the control panel. The display alternately shows the alarm code and the number of times it was triggered.



Example: **M0** _ **05** _ **M0** _ **05** _

Use the  and  keys to scroll through the entire list of alarm counters.

12.1.2 Alarm log

With the third level menus enabled (**AT** → **AA**), go to **SF** → **AH** to see the alarm log (the last 20 alarms recorded). The display shows the alarm number and code, alternated. The highest number corresponds to the most recent alarm and the lowest number corresponds to the oldest alarm.

Example: **- 1** _ **M0** _ **- 1** _ **M0** _

Use  and  to scroll through the alarm log.

12.1.3 Exporting information on the microSD

With the third level menus enabled (**AT** → **AA**), the microSD card inserted and the automation idle, go to **SF** → **AE** to export all the control panel parameters to the microSD. The LCU40H_INFO.txt text file created on the microSD contains all the alarm counters, the log showing the last twenty alarms, the operating statistics and the complete configuration of the control panel.

By inserting the microSD in a PC and opening the file LCU40H_INFO.txt with the Entrematic software, you can view all the control panel data.



NB: when the installation is complete, you are advised to delete the internal data logging.

12.2 Extended data logging on microSD

The Entrematic LCU40H control panel can record every event and/or alarm for every operation performed.

To do this, you must leave a microSD inserted in the relative connector and then, with the third level menus enabled (**AT** → **AA**), set **SF** → **EJ** → **02**.

In this way, at the end of every operation the control panel will save all the events recorded up to that moment on the microSD (in the LCU40H.log file in the LCU40H_LOG folder).

You can view all the recorded logs by inserting the microSD in a PC and opening the LCU40H.log file using the Entrematic software.

This is an example of the visualisation of recorded events:

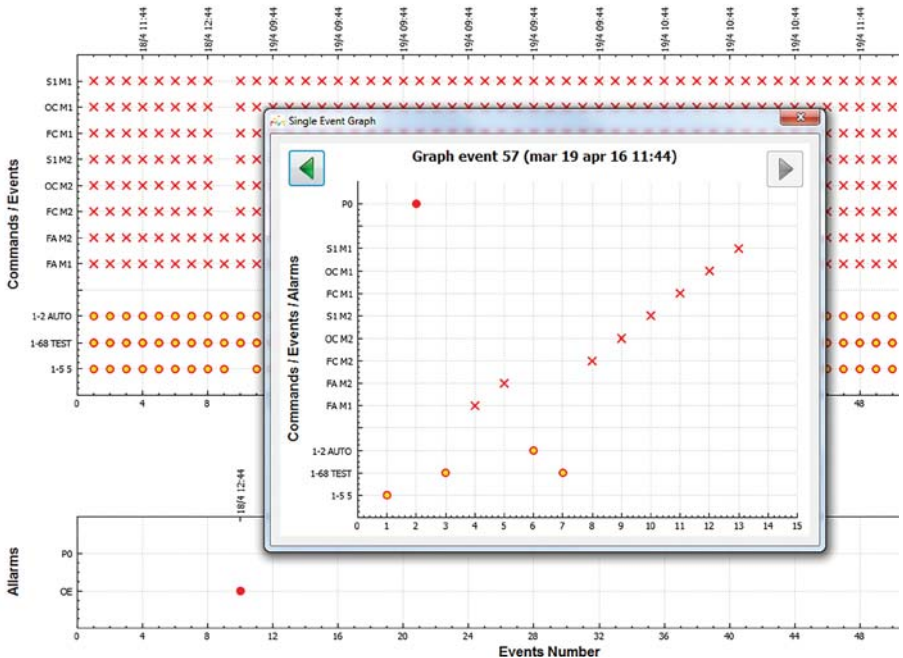









13. Signals visualised on the display

i NB: depending on the type of automation and control panel, certain visualisations may not be available.

13.1 Display of automation status

i NB: the automation status display mode is only visible with Display visualisation mode set to 02.

AP ▶ DS ▶ 02

Display	Description	Display	Description
	Automation closed		Automation opening
	Automation open		Automation closing, from partial opening
	Automation stopped in intermediate position		Automation in partial opening
	Automation closing		Automation partially open

13.2 Display of safety devices and commands

i NB: the safety device and command visualisation mode is only visible with Display visualisation mode set at 01 or 03.

AP ▶ DS ▶ 01

AP ▶ DS ▶ 03

Display	Description	Display	Description
1-2	1-2 - Automatic closing activation command	1-6	1-6 - Safety device with opening and closing stop
1-3	1-3 - Opening command	1-8	1-8 - Safety with closing reversal
1-4	1-4 - Closing command	1-9	1-9 - STOP command
1-5	1-5 - Step-by-step command	68	68 - Partial opening command



Display	Description	Display	Description
P3	P3 - Partial opening command	S2.	S2. - Detection of stop during opening - motor 1
3P	3P - Opening command with operator present	S.2.	S.2. - Detection of stop during opening - motor 2
4P	4P - Closing command with operator present	00.	00. - Reaching of obstacle detection limit during opening - motor 1
R X	RX - Radio reception (of any memorised key of a transmitter present in the memory)	0.0.	0.0. - Reaching of obstacle detection limit during opening - motor 2
N X	NX - Radio reception (of any non-memorised key)	0C.	0C. - Reaching of obstacle detection limit during closing - motor 1
	NB: with the selection <i>AP</i> → <i>DS</i> → <i>0 1</i> it is also visualised when a command is received from a non-stored transmitter.	0.C.	0.C. - Reaching of obstacle detection limit during closing - motor 2
E X	EX - Rolling-code radio reception out of sequence	RV	RV - Enabling/disabling of built-in radio receiver via RDX
EP	EP - Radio reception not complying with the parameter configuration <i>RO</i> → <i>EP</i>	MQ	MQ - Learning operation of mechanical end stops in progress
C X	CX - Command received from AUX1 board	HT	HT - Heating of the motors (NIO function) in progress
C Y	CY - Command received from AUX2 board	J 1	JR1 - Variation of the JR1 jumper status
F.C.	F.C. - Closure limit switch - motor 1	PC	PC - Recognition of connected HOST (Personal Computer)
F.C.	F.C. - Closure limit switch - motor 2	ES	ES - Switch to Green Mode (energy-saving)
F.A.	FA. - Opening limit switch - motor 1	1C	1C - Closing operation (1 gate wing at a time)
F.A.	FA. - Opening limit switch - motor 2	SD	SD - Recognition of microSD card
S 1.	S1. - Detection of stop during closure - motor 1	ED	ED - Log storage on microSD
S. 1.	S.1. - Detection of stop during closure - motor 2		

13.3 Visualisation of alarms and faults



WARNING: the visualisation of alarms and faults is possible with any visualisation selection. The signalling of alarm messages takes priority over all other displays.

Type of alarm	Display	Description	Operation
Mechanical alarm	M0	M0 - Automation type not selected	Select a type of automation from the AT → AS menu
	M4	M4 - Short circuit - motor 1	Check the connection of motor 1.
	M5	M5 - Short circuit - motor 2	Check the connection of motor 1.
	MB	MB - Absence of motor 1 during an operation	Check the connection of motor 1.
	MC	MC - Absence of motor 2 during an operation (if 2-motor functioning has been set)	Check the connection of motor 2.
	MD	MD - Irregular functioning of motor 1 opening limit switch	Check the connection of the motor 1 opening limit switch.
	ME	ME - Irregular functioning of motor 1 closing limit switch	Check the connection of the motor 1 closing limit switch.
	MF	MF - Irregular functioning of motor 2 opening limit switch	Check the connection of the motor 2 opening limit switch.
	MG	MG - Irregular functioning of motor 2 closing limit switch	Check the connection of the motor 2 closing limit switch.
	MH	MH - Door wing overlap not correct	Check that the motor which is the first to make the opening (M1) is connected as shown in fig. 1.
	MI	MI - Detection of third consecutive obstacle	Check for the presence of permanent obstacles along the stroke of the automation.
	OD	OD - Obstacle during opening - gate wing 1	Check for the presence of obstacles along the automation stroke.
	OE	OE - Obstacle during closure - gate wing 1	Check for the presence of obstacles along the automation stroke.
	OF	OF - Obstacle during opening - gate wing 2	Check for the presence of obstacles along the automation stroke.
	OG	OG - Obstacle during closure - gate wing 2	Check for the presence of obstacles along the automation stroke.
Settings alarm	S6	S6 - Incorrect setting of safety device test	Check the configuration of parameters D6, D8, G8 . If G8 → S41 , D6 and D8 cannot be P41 or S41 .
Service alarm	V0	V0 - Request for maintenance intervention	Proceed with the scheduled maintenance intervention.

Type of alarm	Display	Description	Operation
Internal control panel alarm	I5	I5 - No voltage 0-1 (faulty voltage regulator or short-circuit on accessories)	Check there is no short-circuit in connection 0-1. If the problem persists, replace the control panel.
	I6	I6 - Excessive voltage 0-1 (faulty voltage regulator)	Replace the control panel.
	I7	I7 - Internal parameter error - value outside limits	Reset. If the problem persists, replace the control panel.
	I8	I8 - Program sequence error	Reset. If the problem persists, replace the control panel.
	IA	IA - Internal parameter error (EEPROM/FLASH)	Reset. If the problem persists, replace the control panel.
	IB	IB - Internal parameter error (RAM)	Reset. If the problem persists, replace the control panel.
	IC	IC - Operation time-out error (>5 min or >7 min in learning mode)	Manually check that the gate wing moves freely. If the problem persists, replace the control panel.
	IE	IE - Power supply circuit fault	Reset. If the problem persists, replace the control panel.
	IM	IM - MOSFET alarm - motor 1 in short-circuit or always ON	Reset. Check the settings / operating of any limit switches. If the problem persists, replace the control panel.
	IN	IN - MOSFET alarm - motor 2 in short-circuit or always ON	Reset. If the problem persists, replace the control panel.
	IO	IO - Interrupted power circuit - motor 1 (motor MOSFET open or always OFF)	Reset. If the problem persists, replace the control panel.
	IP	IP - Interrupted power circuit - motor 2 (motor MOSFET open or always OFF)	Reset. If the problem persists, replace the control panel.
	IS	IS - Error on current read circuit test - motor 1	Reset. If the problem persists, replace the control panel.
	IT	IT - Error on current read circuit test - motor 2	Reset. If the problem persists, replace the control panel.
	IU	IU - Error on voltage read circuit test - motor 1	Reset. If the problem persists, replace the control panel.
	IV	IV - Error on voltage read circuit test - motor 2	Reset. If the problem persists, replace the control panel.
	XX	XX - Firmware reset commanded by the simultaneous pressing of the  +  keys.	
	WD	WD - Firmware reset not commanded	

Type of alarm	Display	Description	Operation
Radio operations alarm	R0	R0 - Insertion of a storage module containing over 100 stored remote controls Warning: the RO → MU → 20 setting is made automatically.	To save the system configurations on the storage module, delete any stored remote controls and bring the total to less than 100. Set RO → MU → 10 .
	R3	R3 - Storage module not detected	Insert a storage module.
	R4	R4 - Storage module not compatible with the control panel	Insert a compatible storage module.
	R5	R5 - No serial communication with the storage module	Replace the storage module.
	R6	R6 - Insertion of a specific storage module for testing	
Power supply alarm	P0	P0 - No mains voltage	Check the control panel is powered correctly. Check the line fuse. Check the mains power supply.
	P1	P1 - Microswitch voltage too low	Check the control panel is powered correctly.
Battery alarm	B0	B0 - Battery almost flat	Check battery voltage. Replace battery.
Accessories alarm	A0	A0 - Failure of test of safety sensor on contact 6	Check the device SOFA1-A2 is working correctly. If the supplementary SOF board is not inserted, check the safety test is disabled.
	A1	A1 - Simultaneous safety sensor test on contacts 6 and 8 failed	Check the wiring and correct operation of the safety sensor.
	A3	A3 - Failure of test of safety sensor on contact 8	Check the device SOFA1-A2 is working correctly. If the supplementary SOF board is not inserted, check the safety test is disabled.
	A7	A7 - Incorrect connection of contact 9 to terminal 41	Check that terminal 1 and 9 are correctly connected.
	A9	A9 - Overload on output +LP-	Check the device connected to output +LP- is working properly.
	AB	AB - Overload on output 30-13	Check the device connected to output 30-13 is working properly.
	AG	AG - Alarm for short-circuit on output -LK+	Check the device connected to output -LK+ is working properly.

14. Troubleshooting

Problem	Possible cause	Alarm signalling	Operation
The control panel does not switch on	No power supply.		Check the power supply cable and the relative wiring
	Overload on output 0-30		Disconnect any loads connected to terminal 30
The automation does not open or close.	No power.		Check power supply cable.
	Short-circuited accessories	IS	Disconnect all accessories from terminals 0-30 (a voltage of 24V= must be present), then reconnect them one at a time. Contact Technical Service
	Blown line fuse.		Replace fuse.
	Safety contacts are open.	I-6 I-8 6-8	Check that the safety contacts are closed correctly (NC).
	Safety contacts not correctly connected or self-controlled safety edge not functioning correctly.	A0 I-6 A1 I-8 A3 6-8	Check connections to terminals 6-8 on control panel and connections to the self-controlled safety edge.
	Photocells activated.	I-6 I-8	Check that the photocells are clean and operating correctly.
	The automatic closure does not work.		Issue any command. If the problem persists, contact Technical Service
The external safety devices are not activated.	Incorrect connections between the photocells and the control panel.		Check that I-6 / I-8 is displayed Connect NC safety contacts together in series and remove any jumpers on the control panel terminal board.
			Check the AP → J6 and AP → J8 setting
The automation opens/closes briefly and then stops.	There is a presence of friction.	MI	Manually check that the automation moves freely and check the R1/R2 adjustment. Make sure that any limit switches, if present, are working correctly. Contact Technical Service
The remote control has limited range and does not work with the automation moving.	The radio transmission is impeded by metal structures and reinforced concrete walls.		Install the antenna outside.
			Replace the transmitter batteries.
The remote control does not work	No storage module or incorrect storage module.	R0	Switch the automation off and plug in the correct storage module.
		R3 R5	Check the correct memorisation of the transmitters on the built-in radio. If there is a fault with the radio receiver that is built into the control panel, the remote control codes can be read by removing the storage module.

All the rights concerning this material are the exclusive property of Entrematic Group AB.

Although the contents of this publication have been drawn up with the greatest care, Entrematic Group AB cannot be held responsible in any way for any damage caused by possible mistakes or omissions. We reserve the right to make changes without prior notice. Copying, scanning or changing in any way is expressly forbidden unless authorised in writing by Entrematic Group AB.

ENTRE//MATIC



Entrematic Group AB
Lodjursgatan 10
SE-261 44, Landskrona
Sweden
www.entrematic.com

